

SPEARHEAD

MULTICUT 460

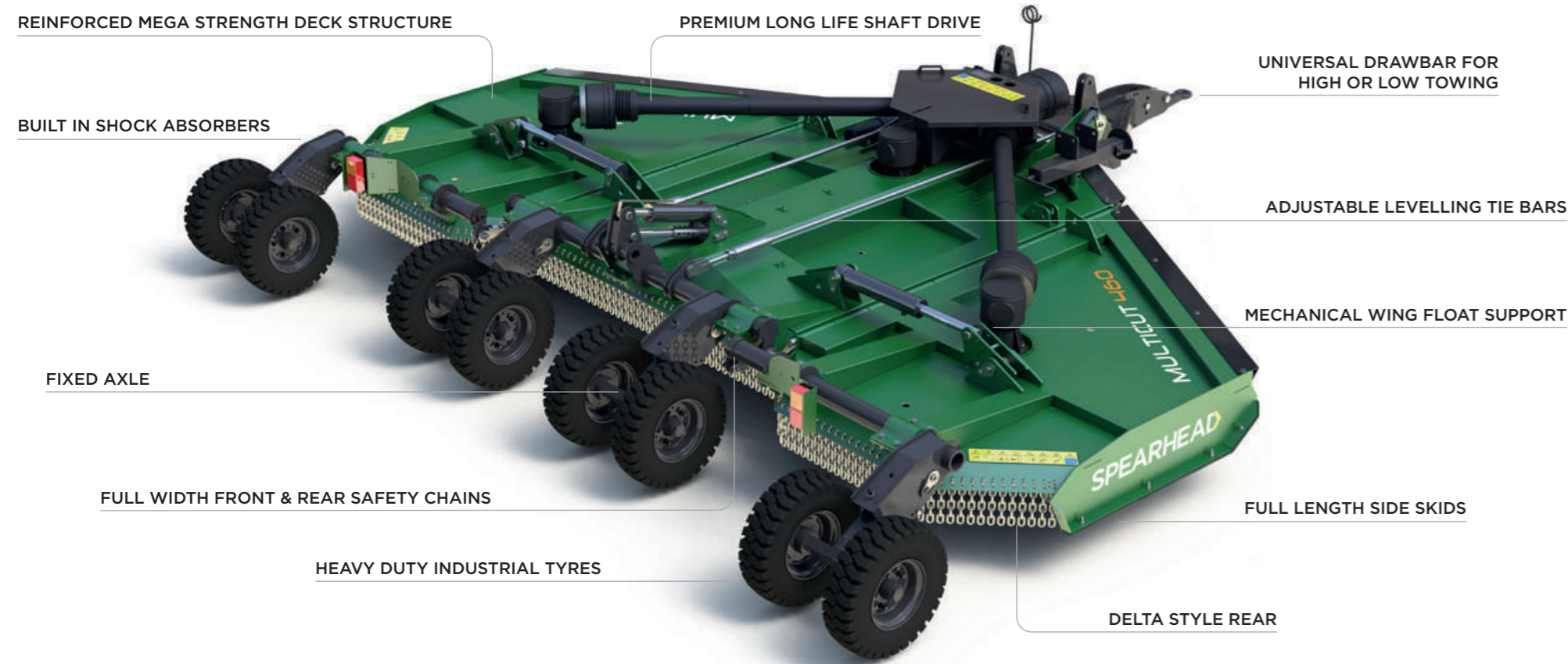

MULTICUT 460 FEATURES



-  AGRICULTURE
-  PASTURE
-  LIGHT SCRUB
-  HEAVY SCRUB
-  AIRFIELD
-  HIGHWAYS
-  STUBBLE MANAGEMENT

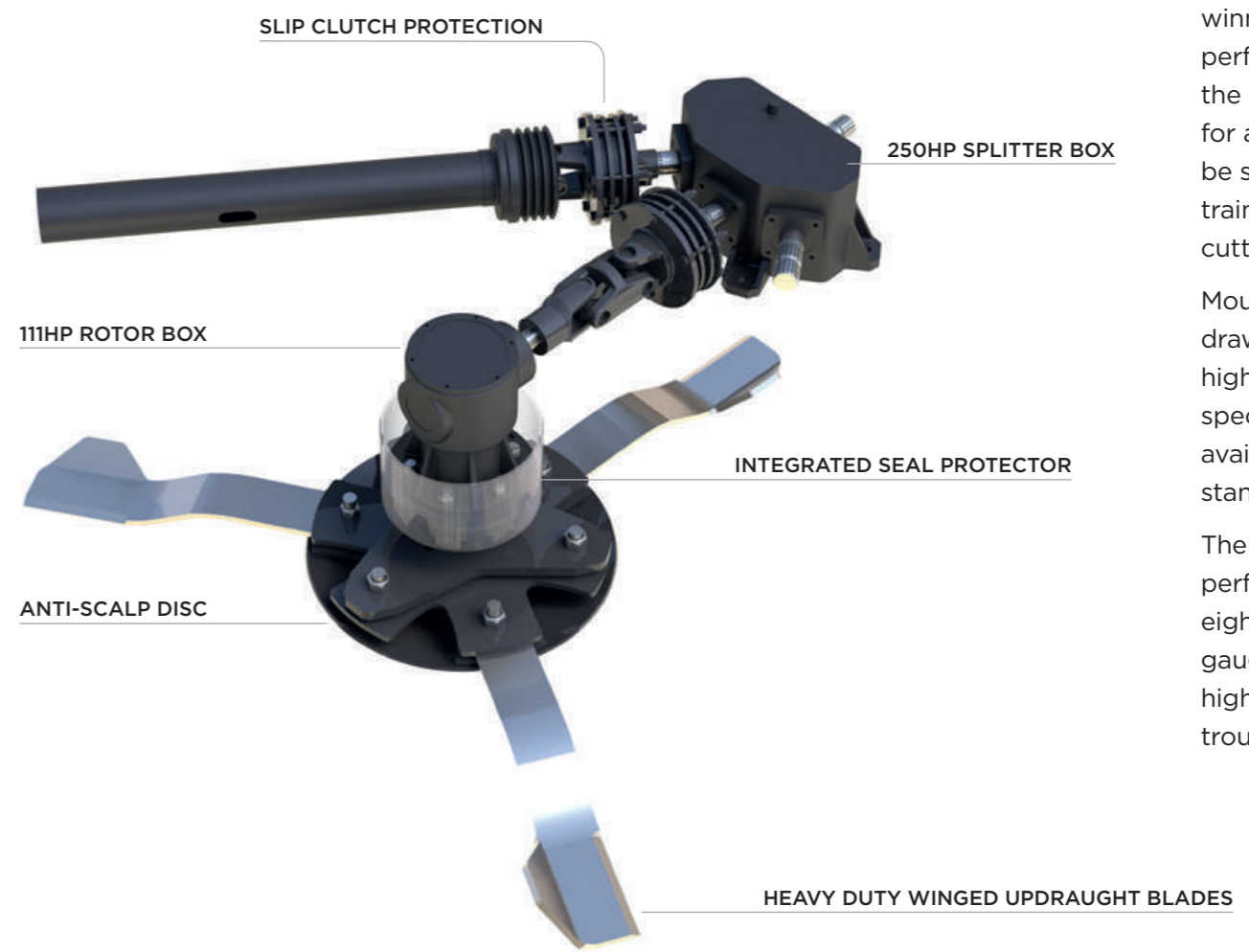









The Multicut 460 has an award winning heritage of reliability and performance that sets it apart from the competition – Whilst initially built for agriculture, it is just as likely to be seen in an airport or on a military training field where the reliability and cutting performance excel.







Mounting is simple with a trailing drawbar that can be set in low or high position dependant on tractor specification, and optional hitch types available to satisfy requirements from standard pintle to K80.

The machine is ultimately built to perform and comes standard with eight tough wheels, a robust heavy gauge fully seam welded deck, and high horsepower gearboxes to ensure trouble free operation.

MULTICUT 460

UNIT OPTIONS

 HP TRACTOR HP	 PTO SPEED	 TRANSPORT WIDTH	 CUTTING WIDTH	 HP GEARBOX RATING	 NO. OF WHEELS	 NO. OF ROTORS	 NO. OF BLADES	 CUTTING HEIGHT
70hp	540 - 1000rpm	2.70m / 106"	4.60m / 181"	250hp & 111hp	8	3	9	25 - 400mm 1" - 16"

 6 BLADE KIT	 HYDRAGAS SUSPENSION	 6, 8 or 21 SPLINE PTO	 SWIVEL TOWING EYE	 K80 TOWING HITCH	 WIDE WHEEL	 540 RPM DRIVE SYSTEM

SPECIFICATION		MULTICUT 460	
Machine weight*	2310kg / 5093lbs	Gearbox oil capacity [rotor gearboxes (x3)]	2.1 litres / 3.7 pints
Hitch	Multi-positional drawbar	Deck construction	All welded construction
Cutting width	4.60m / 181"	Deck material thickness	6mm (1/4")
Working machine width	4.79m / 189"	Side skirt material thickness	5mm (3/16")
Transport machine width	2.70m / 106"	Skid construction	Replaceable bolt on skid shoes
Maximum working length	4.91m / 193"	Anti-scalp dish	6mm (1/4") pan round with blade holder bar
Transport length	4.84m / 191"	Blades (x9)	12mm (1/2") 30 Carbon Boron hardened and tempered. Free swinging high lift - low friction
Deck height**	0.23m / 9"	Blade bolts	M24 C/W shank grade 8.8
Transport height	2.17m / 86"	Blade tip speed (1000rpm)	80mps / 15748fpm
Cutting height	25mm - 400mm (1" - 16")	Driveline	ASAE Category 6
Cutting capacity	100mm / 4"	Driveline protection	2-way slip clutches on rotor gearboxes. Overrun on input shaft
Recommended tractor HP	70hp / 52kW	Tailwheel mount assemblies	Tubular welded axle
Wing working angles	45° up / 15° down	Tailwheels (x8)	600-9 10 PLY pneumatic tyre with steel hub
Power take-off speed	1000rpm (540rpm optional)	Front guard	Single chain guards on each deck
Gearbox [splitter]	Cast Iron housing	Rear guard	Single chain guards on each deck
Gearbox [rotor gearboxes (x3)]	Cast Iron housing		
Input Shaft	1" 3/8 Z21 or Z6 SFT 6/8 tractor end		
Gearbox lubricant	EP80-90W or GL-4 / GL-5 oil		
Gearbox lubricant oil capacity [splitter gearbox]	2.7 litres / 4.7 pints		

*With front and rear single chain guards ** Underside of deck to skid

SPEARHEAD

📍 Station Road, Salford Priors, Evesham, Worcestershire, WR11 8SW, England ☎ +44 (0)1789 491860

✉ enquiries@spearheadmachinery.com 📧 spearheadmachinery.com 🐦 📘 SpearheadWorld



designed and built in
GREAT BRITAIN



Spearhead
is a member of the
Alamo Group